

**miro barhocker 11-580**

Hannes Wettstein, 2004  
Sitz Formsperrholz, Holzgestell massiv  
B34, T34, SH80

Hannes Wettstein, 2004  
Assise en contreplaqué moulé, piètement en bois massif  
L34, P34, HAss80.

Hannes Wettstein, 2004  
Moulded plywood seat, solid wooden frame  
W34, D34, SH80

## Varianten / variantes / variants



Miro  
11-560



Miro  
6-400



Miro  
6-400a



Miro  
6-403



Miro  
6-403a



Miro  
11-300



Miro  
11-400



Miro  
11-403



Miro  
11-303

## Technische Angaben / specifications / specifications

## Masse / mesure / measure



34 cm  
13.4 in

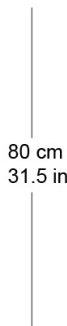

80 cm  
31.5 in



34 cm  
13.4 in

Gewicht / ponds / weight 4.2 kg 8.4 lb

**miro barhocker 11-580**

Holzarten / types de bois / types of wood

Belag / revêtement / surface



Buche natur      BN 000 AM  
Beech natural    BN 000 AM  
Hêtre naturel    BN 000 AM



Buche schwarz      BB 203 SG  
Beech black        BB 203 SG  
Hêtre noir         BB 203 SG



Eiche natur        EN 000 AM  
Oak natural        EN 000 AM  
Chêne naturel     EN 000 AM



Buche anthrazit    BB 200 SG  
Beech anthracite   BB 200 SG  
Hêtre anthracite   BB 200 SG



Esche natur        FN 000 AM  
Ash natural        FN 000 AM  
Frêne naturel     FN 000 AM



Eiche Räuchereiche EB 535 AM  
Oak smoked oak    EB 535 AM  
Chêne chêne fumée EB 535 AM



Buche geweisst    BG 172 SG  
Beech whitewashed BG 172 SG  
Hêtre teinté blanc BG 172 SG



Buche Ebony        BB 100 SG  
Beech ebony        BB 100 SG  
Hêtre teinté ebony BB 100 SG



Esche weisspigmentiert FW 001 OL  
Ash white-pigmented FW 001 OL  
Frêne pigmenté blanc FW 001 OL



Buche Nuss         BB 151 SG  
Beech walnut       BB 151 SG  
Hêtre teinté noyer BB 151 SG



Esche schwarz      FB 203 AM  
Ash black            FB 203 AM  
Frêne noir            FB 203 AM